

CERTIFICATE OF DISTRIBUTORSHIP

To: **MTV ENGINEERING TRADING CO., LTD**

Dear Mr. Thang,

This is to certify that **MTV ENGINEERING TRADING CO., LTD**
Address: A2-12 Cotec Quater, Nguyen Binh street, Phu Xuan ward, Nha Be district,
HoChiMinh City, Viet Nam
Tel.: +84 902 678 626
Email: mtvinfo@mtvco.com.vn
Website: www.mtvco.com.vn

has been appointed the Official Distributor of the Ductile Cast Manhole Covers-
IRON brand in Vietnam.

Dated August 5th 2022

SIGNED BY

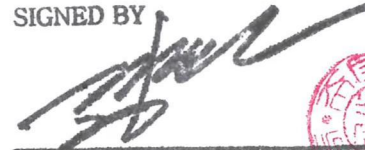

KIM, KI HYUN
PRESIDENT OF KINAM METAL



KINAM METAL CO., LTD.
Signature for and on behalf of Manufacturer

WE ARE ALWAYS PROACTIVE

Premium Manhole Cover

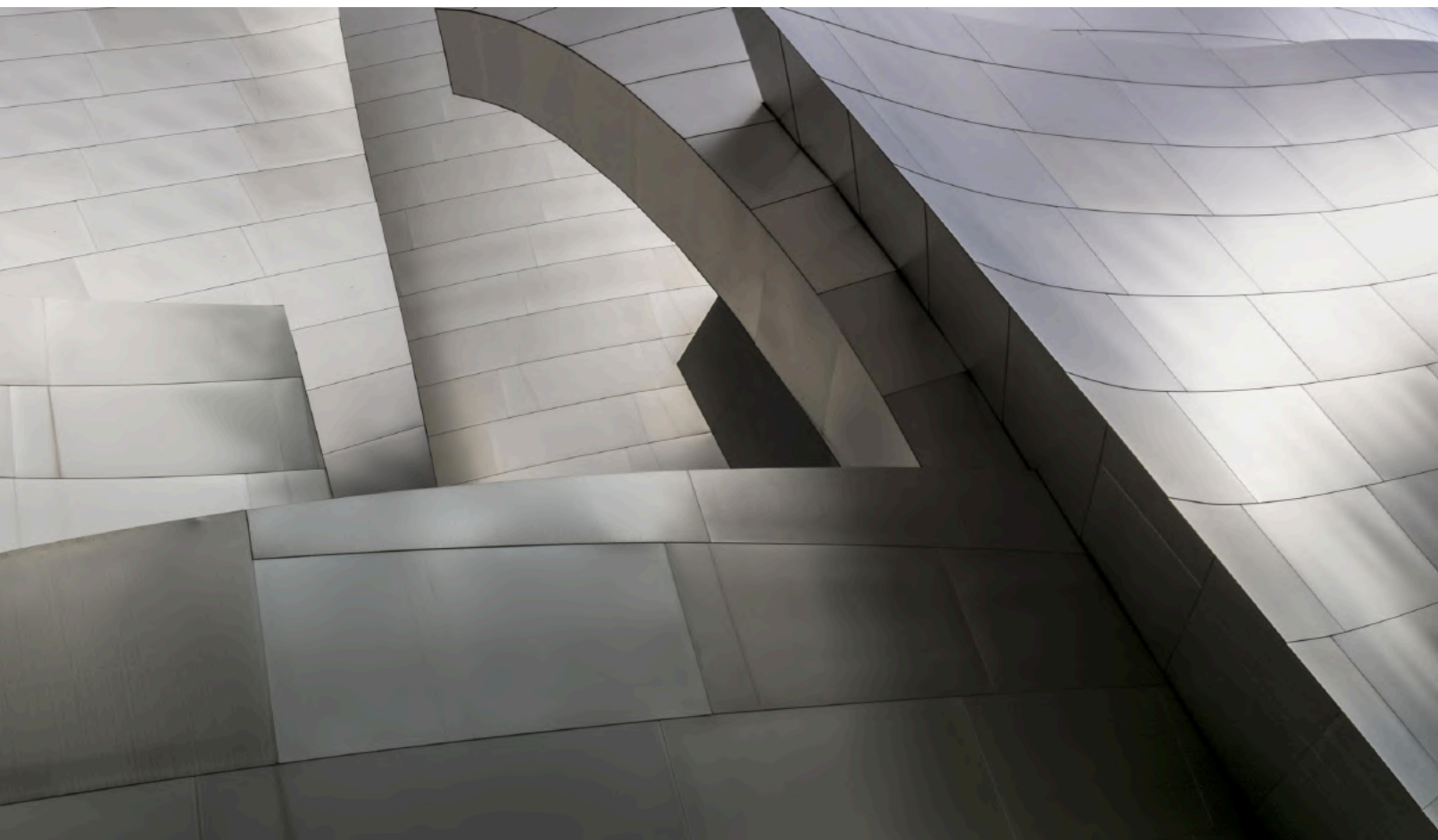

CONTENTS

ABOUT MANHOLE COVER

LOAD CLASSIFICATION
MATERIAL; DUCTILE CAST IRON

MULTI-FUNCTION TYPES

CAM LOCK HINGED DOUBLE TRIANGLE COVERS(AOT)
NOISELESS ELASTIC AND 4 BOLT LOCK DRAIN COVERS
ANTI-ODOR BOLT LOCK HINGED DRAIN COVERS(400/900)
TURN LOCK HIDDEN HINGED MANHOLE COVERS
NOISELESS GAS DISCHARGE RISING LOCK HINGED COVERS

CIRCULAR TYPES

ELASTIC LOCK HINGED DRAIN COVERS
BOLT LOCK HINGED SEWER COVERS
CIRCULAR DRAIN COVERS
CIRCULAR DOUBLE SEALED SEWER COVERS
BOLT LOCK GASKETED WATERTIGHT COVERS
BOLT LOCK HINGED SEWER COVERS

RECTANGULAR TYPES

ELASTIC LOCK HINGED DRAIN COVERS
BOLT LOCK HINGED DRAIN COVERS
BOLT LOCK HINGED SEWER COVERS
ELASTIC LOCK HINGED HALF-V DRAIN COVERS
NOISELESS BOLT LOCK TRENCH GRATES
CAM LOCK QUADRUPLE TRIANGLE COVER
DOUBLE SEALED SQUARE SEWER COVERS
INFILL ACCESS COVER WITH HALF-V GRATES

KOREAN PUBLIC PROCUREMENT TYPES

DESIGN INFILL ACCESS COVERS
NOISELESS DRAIN COVERS

KINAM SOLUTIONS

DOMESTIC
OVERSEAS

COMPANY OVERVIEW

GREETINGS
KINAM'S HISTORY
FACILITIES & PRODUCTION PROCESS
QUALITY MANAGEMENT SYSTEM
CERTIFICATES & PATENTS



ABOUT KINAM

Established in 1999, Kinam Metal, a Manufacturer of Ductile cast Iron Manhole Covers in South Korea, prioritizes customer satisfaction.

Kinam Metal has the highest manhole industry market share in South Korea and is exporting the highest quality products to approximately 10 countries including ASEAN and OCEANIA. To export, we have obtained certifications such as CE, European Standard (EN124), ISO (9001, 14001: 45001) and more with our proven quality.

We possess the greatest engineering capabilities and we have introduced more than 10 latest MCT and CNC precision machining equipment.

With these engineering capabilities as our foundation, we have over 50 different types of patents and more than 300 kinds of products. Furthermore, through aesthetically superior Manhole covers, we are creating new street cultures in South Korea.

Above all, Kinam Metal has been focusing on meeting the needs of our customers. We have overwhelmingly superior quality, reasonable cost, and dependable delivery, through which we promise to become your reliable partner.

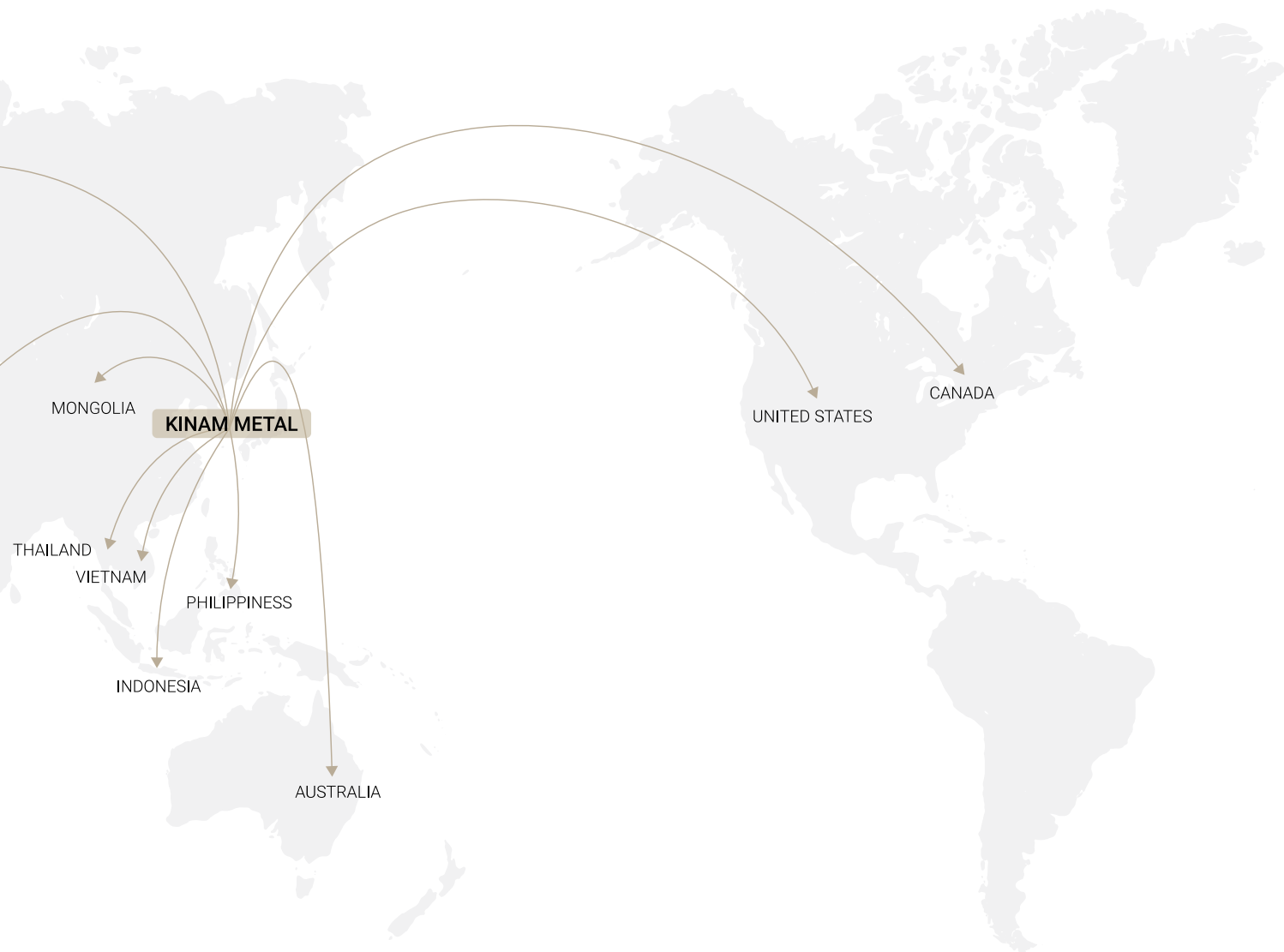

LOAD CLASSIFICATION ACCORDING TO EN124

The appropriate class of manhole top or gully top to be used depends upon the place of installation.

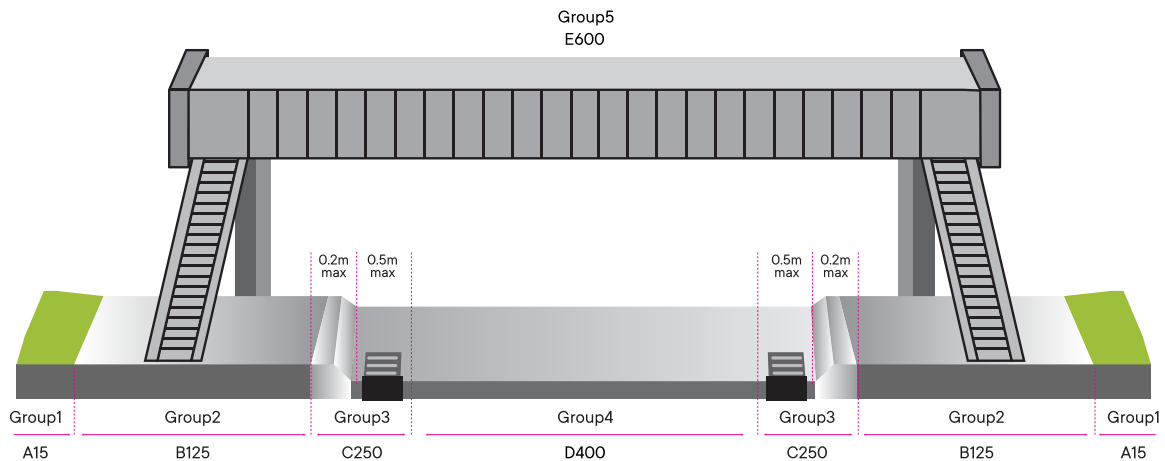

Group 1 (Min. class A15)

Areas which can only be used by pedestrians and pedal cyclists.



Group 2 (Min. class B125)

Footways, pedestrian areas and comparable areas, car parks or car parking decks.



Group 3 (Min. class C250)

For gully tops installed in the area of kerbside channels of roads.



Group 4 (Min. class D400)

Carriageways of roads (including pedestrian streets), hard shoulders and parking areas, for all types of road vehicles.



Group 5 (Min. class E600)

Areas imposing high wheel loads, e.g. docks, aircraft pavements



Group 6 (Min. class F900)

Areas imposing particularly high wheel loads, e.g. aircraft pavements.

MATERIAL DUCTILE CAST IRON

As known as ductile cast iron, nodular cast iron, and spheroidal graphite iron.

D.I.

Suitable for premium quality manhole cover

Ductile iron has spheroidal graphite, which is different from flake shaped graphite found in grey iron. This spheroidal graphite is accomplished by adding an inoculant; magnesium, to molten iron.

Tougher and lighter the strong successor of Grey iron

Ductile iron manhole cover has 3 big advantages over grey iron cover.

1. Higher strength, but still lighter; Ductile Iron has approximately twice the strength of Cast Iron as determined by tensile, beam, ring bending, and bursting tests.
2. Follows the industry's most strict and up-to-date standards; The standards for ductile iron require higher performance.
3. Less likely to break; spheroidal form results in enhanced ductility, which prevents the breakage when overloaded.



Class	A15	B125	C250	D400	E600	F900
Min. Loads	15kN 1.5ton 3,300lb	125kN 12.5ton 28,100lb	250kN 25ton 56,200lb	400kN 40ton 90,000lb	600kN 60ton 135,000lb	900kN 90ton 202,000lb
	Light Duty		Standard Duty		Heavy Duty	

KINAM FOCUS ON



- Research Institute of Technology
- Government Procurement
- Fast feedback
- Mass production
- Customizable
- Wide range of products
- Precision machined
- Auto-moulding Lines

PRODUCT CODE

KINAM has a wide range of manhole covers

Easy / Convenient / Safe

KN-D6060H-EL

Drain C/O 600×600 Hinge Elastic Locking or other special options

- We have a variety of security lock systems
- It's noiseless by inserting EPDM rubber or processing precision machining
- We provide multiple functions; Noiseless / Watertight / Gas-discharge / odor-prevention etc.
- It's easy and convenient for workers to open and close the manhole covers by user-friendly hinge
- Many holes in the long oval shape make effective drainage possible
- One person can operate the manhole covers. It's cost-effective labor
- Safety bar minimizes hazard
- It's safe for pedestrians by anti-slip patterns on the cover
- We complete the manhole covers with stainless steel parts that prevent corrosion

38495. 6, Iryeon-ro 115-gil, Jillyang-eup, Gyeongsan-si, Gyeongbuk, Korea

T.+82.53.815.6114 F.+82.53.815.6118 <http://www.kinam.co.kr>

CERTIFICATES & PATENTS



GOOD DESIGN & Certificate of Design Registration

- Certificate of Design Registration 2011
- Certificate of Design Registration 2005
- Certificate of Design Registration 2007
- Certificate of Design Registration 2008
- Certificate of GOOD DESIGN Selection

Commendation & Certificate

- Factory Registration Document
- Certificate of Commendation
- Product Certificate
- Confirmation Document of Direct Production
- Certificate of Quality Assurance
- Certificate of CreBiz QM

Certificate of Utility Model Registration

- Opening device for Manhole Cover
- Grating for drainage
- Manhole Cover equipped with noise prevention device

Certificate of Patent

- Locking device of Noiseless Manhole cover
- Watertight device of Manhole cover
- Manhole cover with odor-prevention plate
- Locking device of Manhole cover
- Manhole cover that can relieve backflow and noise and how to operate it



CAM LOCK HINGED DOUBLE TRIANGLE COVERS(AOT)

Model Code	EN124 Class	Clear Opening(mm)	Overall Dimension (mm)	Height (mm)
KN-S100100H-CL	D400/E600	1000×1000	1153×1262	200

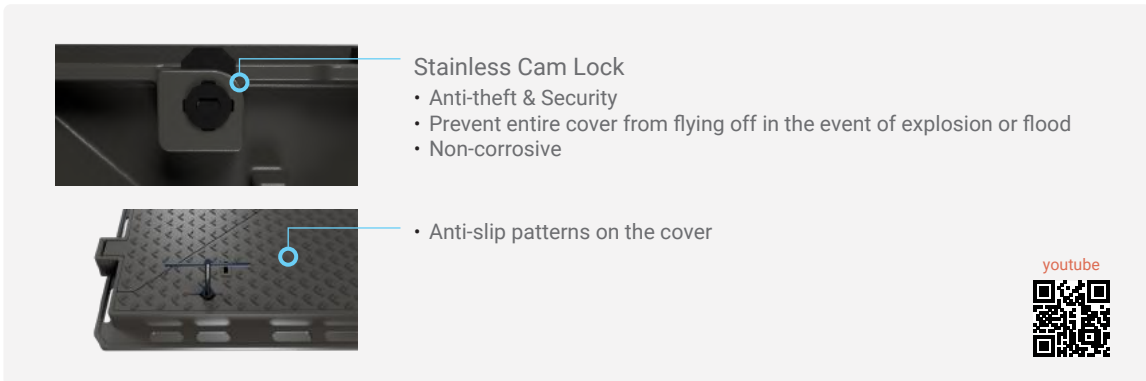
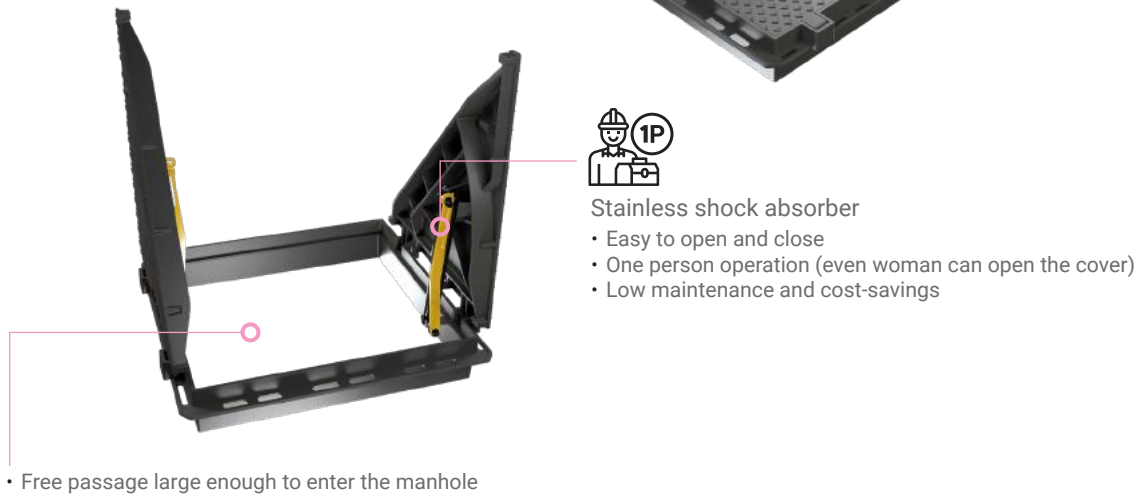

• Custom logo or lettering

Opener



NOISELESS ELASTIC AND 4 BOLT LOCK DRAIN COVERS

Model Code	EN124 Class	Clear Opening(mm)	Overall Dimension (mm)	Height (mm)
KN-D6060H-ELBL	C250	600×600	760×760	60
KN-D8080H-ELBL	C250/D400	800×800	930×930	60



- Hinge & Elastic Lock + Stainless Bolt Lock
- Anti-theft and Security
 - Prevent entire cover from flying off in the event of explosion or flood
 - Non-corrosive and Long-lasting

Taper machining

- Completely Noiseless
- Cover is 1.5~2mm away from the frame through taper vertical MCT machining

• 1.5~2mm

youtube

- Custom logo or lettering
- Color painting
- Left-Hinge

Opener



ANTI-ODOR BOLT LOCK HINGED DRAIN COVERS(400)

Model Code	EN124 Class	Clear Opening(mm)	Overall Dimension (mm)	Height (mm)
KN-D4040H-BL	C250	392×392	528×474	75

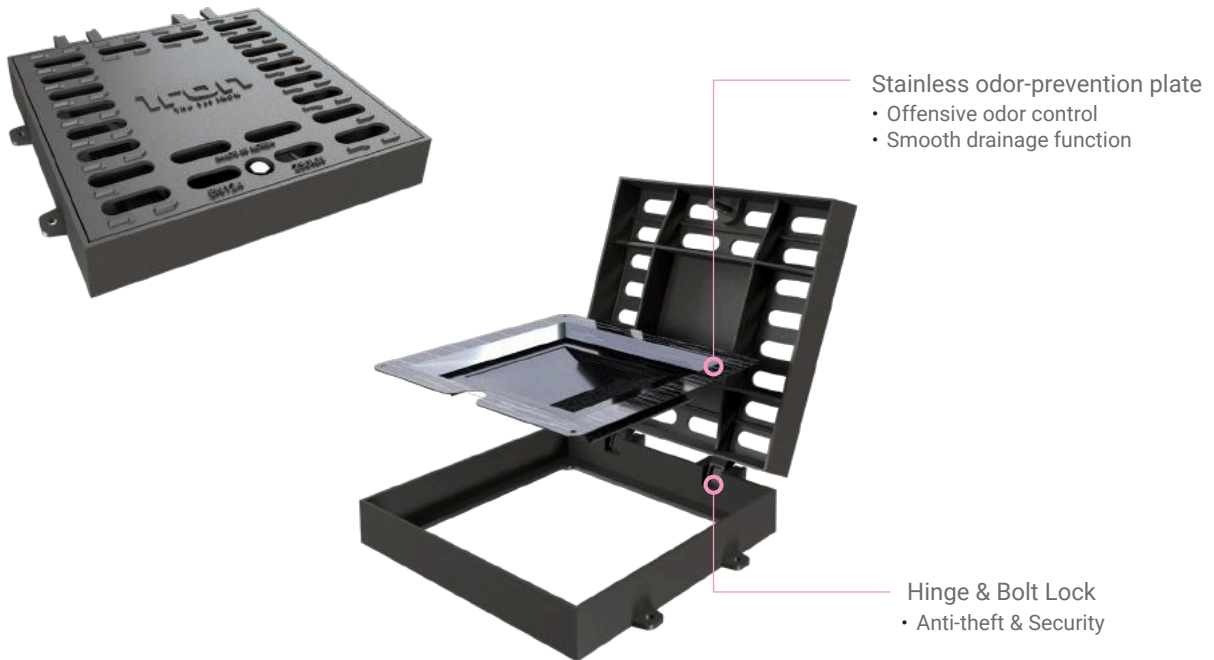

- Custom logo or lettering
- Color painting

Opener



ANTI-ODOR BOLT LOCK HINGED DRAIN COVERS (900)

Model Code	EN124 Class	Clear Opening(mm)	Overall Dimension (mm)	Height (mm)
KN-D9090H-BL	C250	800×800	1060×1050	75

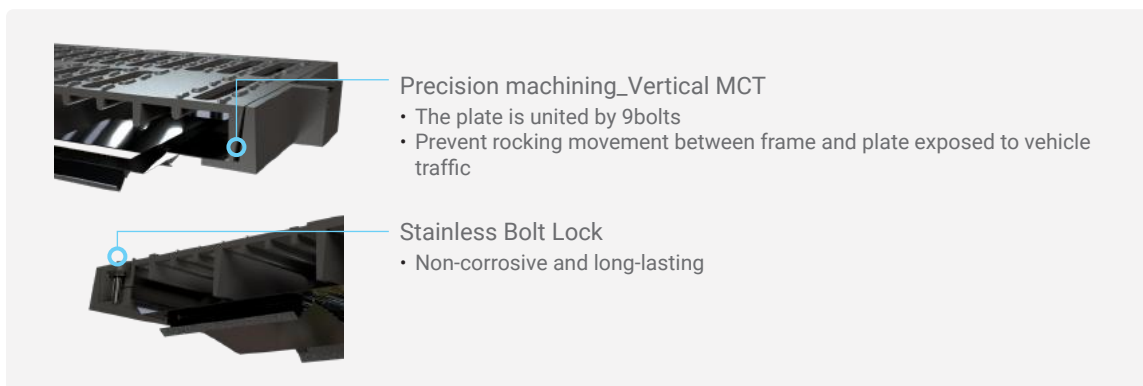

- Custom logo or lettering
- Color painting

Opener



TURN LOCK HIDDEN HINGED MANHOLE COVERS

Model Code	EN124 Class	Clear Opening(mm)	Overall Dimension (mm)	Height (mm)
KN-S625H-TL	D400	Φ625	800×800	140



Hidden Hinge
 • Easy to open the cover up to 180°
 • Operated by one person

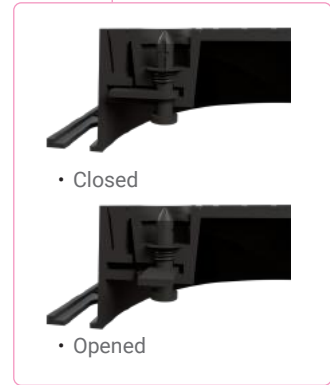

Precision machining
 • No gap between cover and frame

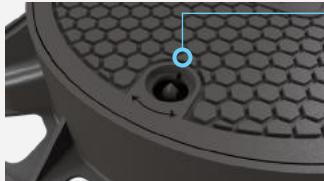

Turn Lock

- Anti-theft and powerful security
- Appropriate for Telecommunication manhole covers
- To be opened only by specified key(customized opener)

- Custom logo or lettering
- Color painting

Customized Opener



NOISELESS GAS DISCHARGE RISING LOCK HINGED COVERS

Model Code	EN124 Class	Clear Opening(mm)	Overall Dimension (mm)	Height (mm)
KN-S9060H-RL	B125	900×600	1070×775	75
KN-S9060H-RL	D400	900×600	1070×775	115



Hinge & Rising Bolt Lock(stainless)

- Anti-theft & Security
- Prevent entire cover from flying off in the event of explosion or flood
- Easy to open and close

Safety bar

- Cover opens up to 105°
- Accident prevention & safe for workers

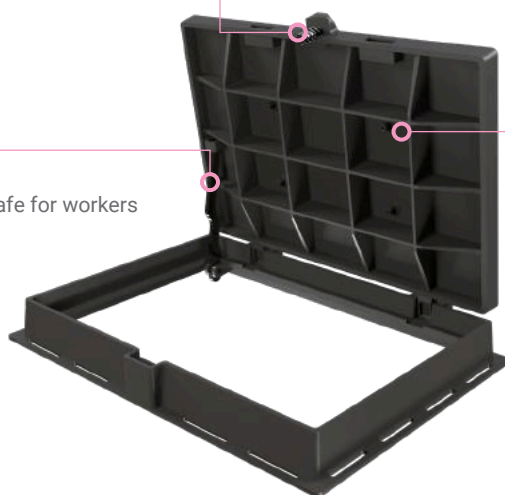

Certificate of patent no : 10-2020-0088201

Gas discharge valve with sound of danger sign by plastic squeaker

- Prevent explosion by internal pressure such as methane gas inside the sewage manhole and gas leakage inside the gas manhole
- Putting out a sound of danger sign when gas leaking
- Prevent mosquito breeding

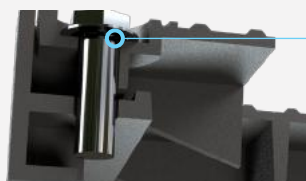

- EPDM Rubber
- Noise-proof

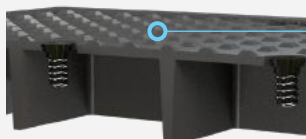

- Anti-slip surface (patterns)



SS30:1999(2012) TEST CERTIFICATE

- Custom logo or lettering
- Color painting

Opener



youtube

ELASTIC LOCK HINGED DRAIN COVERS

Model Code	EN124 Class	Clear Opening(mm)	Overall Dimension (mm)	Depth (mm)
KN-D600H-EL	C250	Φ600	Φ735	70
KN-D800H-EL	C250	Φ800	Φ930	70



Hinge & Elastic Lock

- Anti-theft
- Operated by one person
- Easy to open and close

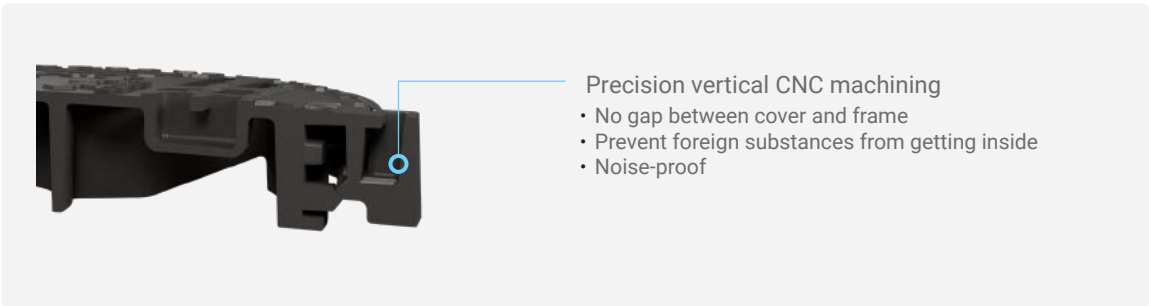

Precision vertical CNC machining

- No gap between cover and frame
- Prevent foreign substances from getting inside
- Noise-proof

- Custom logo or lettering
- Color painting
- Solid cover possible

Opener



BOLT LOCK HINGED SEWER COVERS

Model Code	EN124 Class	Clear Opening(mm)	Overall Dimension (mm)	Height (mm)
KN-S600H-BL	C250	φ600	φ810	100
KN-D800H-BL	C250/D400	φ800	φ930	60

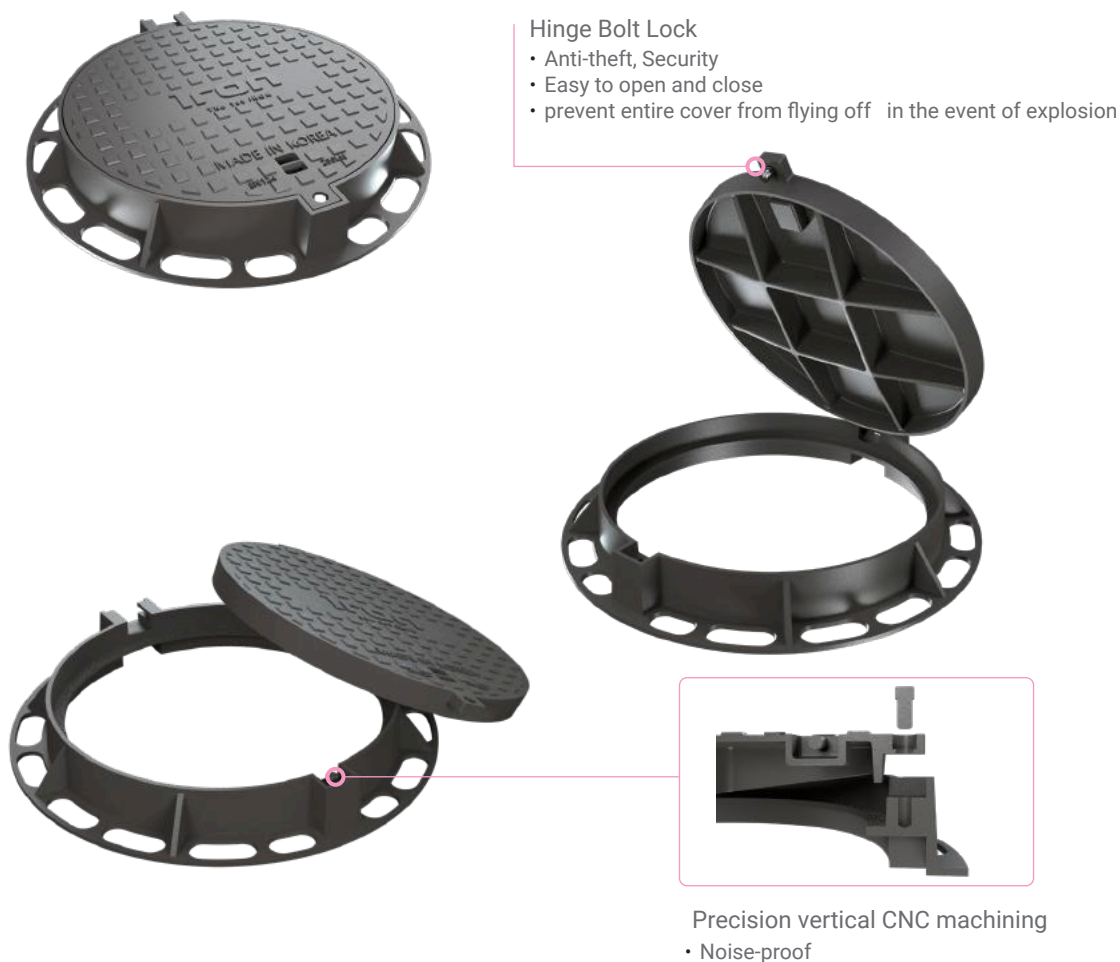

- Custom logo or lettering
- Color painting
- Drainage cover possible

Opener



CIRCULAR DRAIN COVERS

Model Code	EN124 Class	Clear Opening(mm)	Overall Dimension (mm)	Height (mm)
KN-D770	C250	Φ770	Φ900	150
KN-S770	C250	Φ770	Φ900	150
KN-S600	B125	φ600	690×690	50



Drainage holes

- Fast drainage(Optimized for Southeast Asian (Countries))



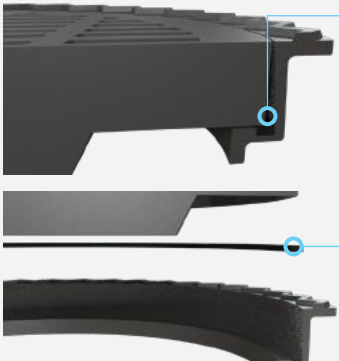

Precision vertical CNC machining

- No gap between cover and frame
- Noise-proof
- Prevent foreign substances from getting inside

• Insert flat EPDM60 rubber

- Custom logo or lettering
- Color painting
- Solid cover possible

Opener



CIRCULAR DOUBLE SEALED SEWER COVERS

Model Code	EN124 Class	Clear Opening(mm)	Overall Dimension (mm)	Height (mm)
KN-S600DS	B125	φ600	φ877	60
KN-S800DS	B125/C250	φ800	φ1077	60
KN-S1000DS	C250	φ1000	φ1220	50



Double sealed
• Odor prevention

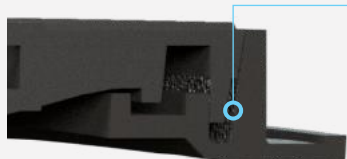

Precision machining

- Completely Noiseless
- Prevent foreign substances from getting inside
- No gap between cover and frame
- Cover is 5mm away from the frame through taper precision vertical CNC machining

- Custom logo or lettering
- Color painting

Opener



BOLT LOCK GASKETED WATERTIGHT COVERS

Model Code	EN124 Class	Clear Opening(mm)	Overall Dimension (mm)	Height (mm)
KN-S600WT-3BL	C250	Φ600	Φ804	100
KN-S800WT-5BL	D400	Φ800	Φ1004	100



- 5 bolt Locks (M16 Stainless Socket Head Wrench Bolt)
- Security
 - Prevent entire cover from flying off in the event of explosion or flooding
 - Φ600- 3 bolts
 - Φ800- 5 bolts
 - Anti-slip



Precision vertical CNC machining

- Noiseless
- No gap between the cover and frame through precision machining
- Prevent foreign substances from getting inside



- Insert flat EPDM60 rubber

- Custom logo or lettering
- Color painting

Opener



BOLT LOCK HINGED SEWER COVERS

Model Code	EN124 Class	Clear Opening(mm)	Overall Dimension (mm)	Height (mm)
KN-5600H-BL	D400	φ600	φ800	190



Hinge & Bolt Lock

- Security
- Easy to open and close

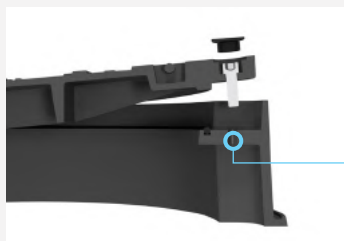

Completely processed by precision machining and EPDM rubber insertion

- Watertight & Noise-proof

Opener



ELASTIC LOCK HINGED DRAIN COVERS

Model Code	EN124 Class	Clear Opening(mm)	Overall Dimension (mm)	Height (mm)
KN-D3550H-EL	C250	350×500	350×500	60
KN-D3070H-EL	C250	300×700	460×770	60
KN-D4040H-EL	C250	400×400	530×560	60
KN-D6060H-EL	C250/D400	600×600	760×765	60
KN-D7262H-EL	D400	725×625	865×765	60
KN-D8080H-EL	C250	800×800	930×950	60
KN-S8080H-EL	C250	800×800	930×930	60

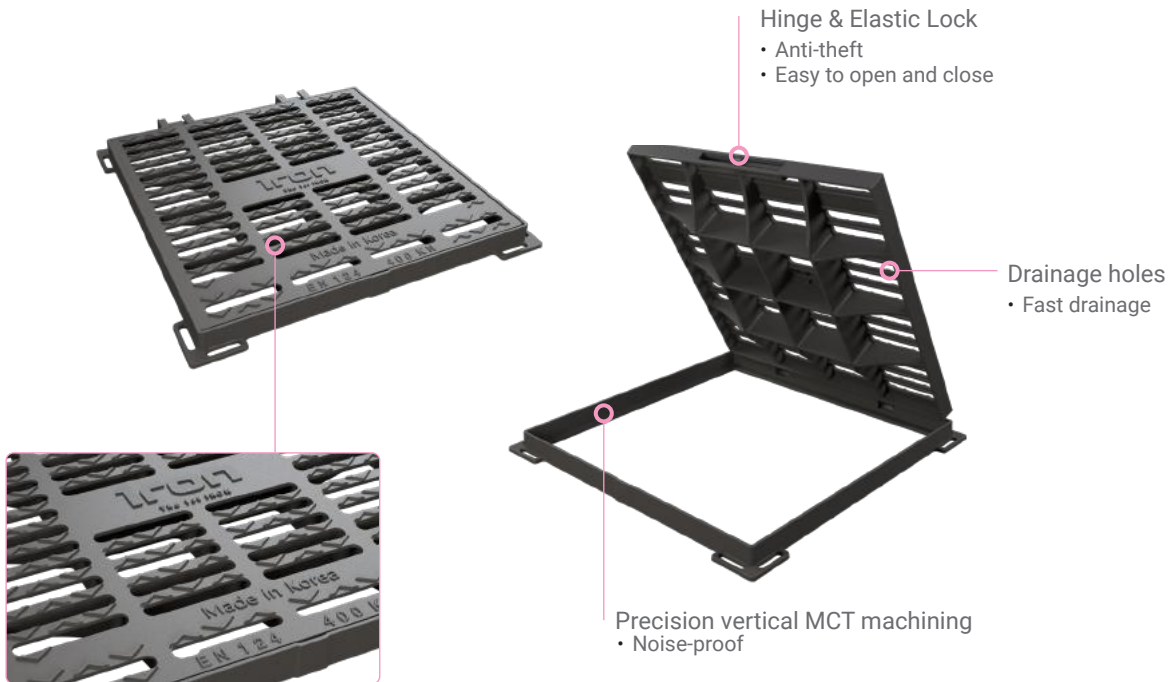

- Custom logo or lettering
- Color painting
- Sewage cover possible

Opener



BOLT LOCK HINGED DRAIN COVERS

Model Code	EN124 Class	Clear Opening(mm)	Overall Dimension (mm)	Height (mm)
KN-D6060H-BL	C250/D400	600×600	750×760	75
KN-D8080H-BL	C250/D400	800×800	960×954	75
KN-D9090H-BL	C250	900×900	1060×1000	75



Anti-slip



Hinge & Bolt Lock
 • Anti-theft and Security
 • Easy to open and close



EPDM Rubber
 • Noise - proof

High durability up to 40 Tons

Stainless Bolt Lock (Hexagon Head Bolt)
 • Non - Corrosive (Hexagon Head Bolt) and Long-Lasting

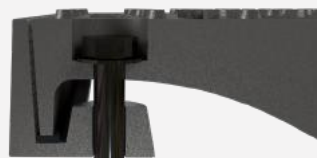

- Custom logo or lettering
- Color painting
- Left Hinge
- Sewage cover possible

Opener



BOLT LOCK HINGED SEWER COVERS

Model Code	EN124 Class	Clear Opening(mm)	Overall Dimension (mm)	Height (mm)
KN-S3333H-BL	B125	336×336	400×400	45
KN-S4848H-BL	B125	488×488	600×600	50



• Anti-slip patterns on the cover



Hinge & Bolt Lock
 • Anti-theft and Security
 • Easy to open and close

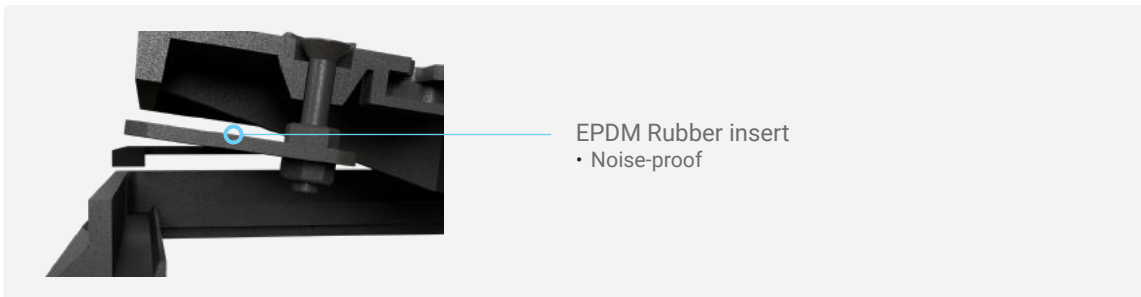

EPDM Rubber insert
 • Noise-proof

- Custom logo or lettering
- Color painting

Opener



ELASTIC LOCK HINGED HALF-V DRAIN COVERS

Model Code	EN124 Class	Clear Opening(mm)	Overall Dimension (mm)	Height (mm)
KN-D6060VH-EL	C250	760×760	600×600	100
KN-D6060VH-EL	C250	760×760	600×600	150
KN-D6060VH-EL	C250	740×740	600×600	75
KN-D8080VH-EL	C250	980×1050	800×800	100
KN-D4942VH-EL	C250	420×490	560×630	75



Click Lock & Hinge
 • Anti-theft
 • Easy to open and close

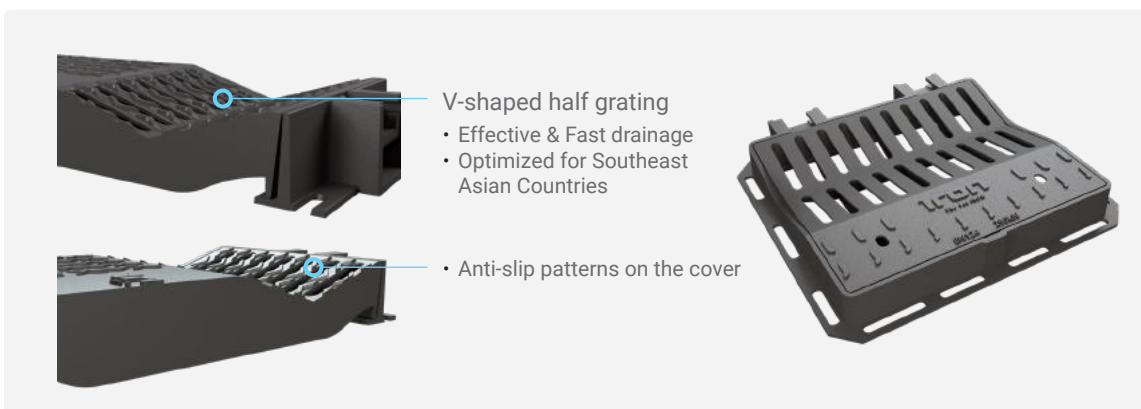
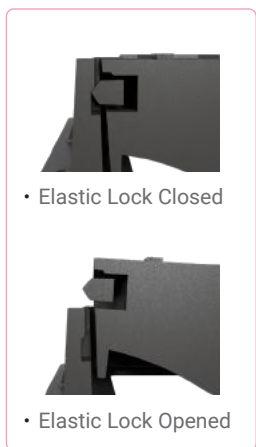

- Custom logo or lettering
- Color painting

Opener



NOISELESS BOLT LOCK TRENCH GRATES

Model Code	EN124 Class	Clear Opening(mm)	Overall Dimension (mm)	Height (mm)
KN-TG7345-BL	C250	730×450	900×500	60

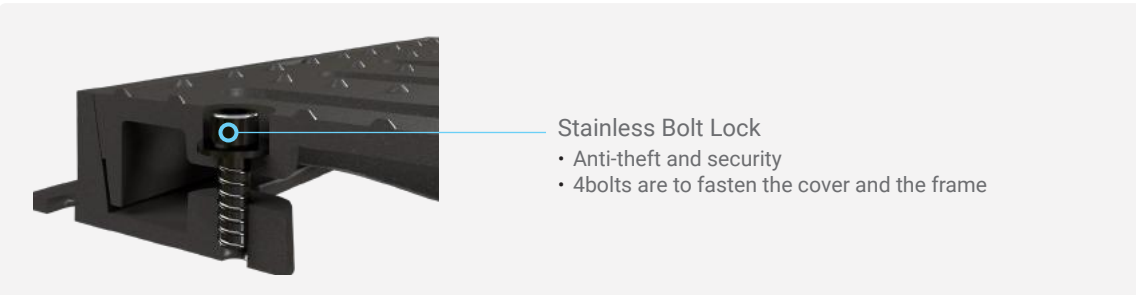

- Custom logo or lettering
- Color painting

Opener



CAM LOCK QUADRUPLE TRIANGLE COVERS

Model Code	EN124 Class	Clear Opening(mm)	Overall Dimension (mm)	Height (mm)
KN-S10670QT-CL	B125	1060×700	1250×870	80
KN-S10670QT-CL	D400	1060×700	1250×870	80



Safe Hinge

- Safeguards to keep the cover from closing suddenly
- Convenient and safe for workers

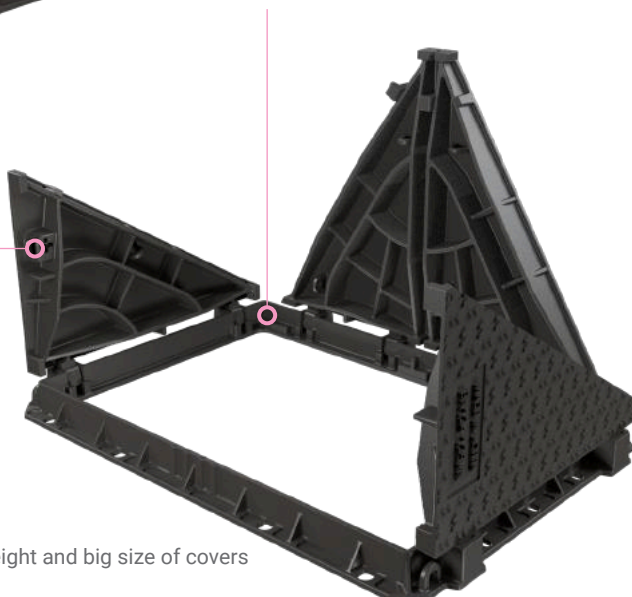

Cam Lock – 1lock 4covers

- Anti-theft and high security
- Easy to open and close even though its heavy weight and big size of covers

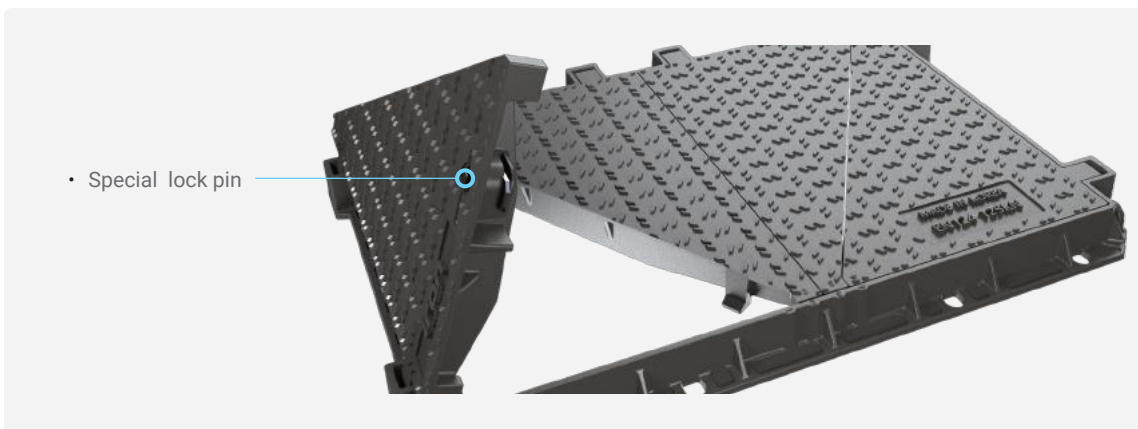

- Special lock pin

- Custom logo or lettering

Opener



DOUBLE SEALED SQUARE SEWER COVERS

Model Code	EN124 Class	Clear Opening(mm)	Overall Dimension (mm)	Height (mm)
KN-S6060DS	C250	600×600	800×800	60
KN-S8080DS	C250	800×800	1000×1000	60
KN-S100100DS	C250	1000×1000	1200×1200	60

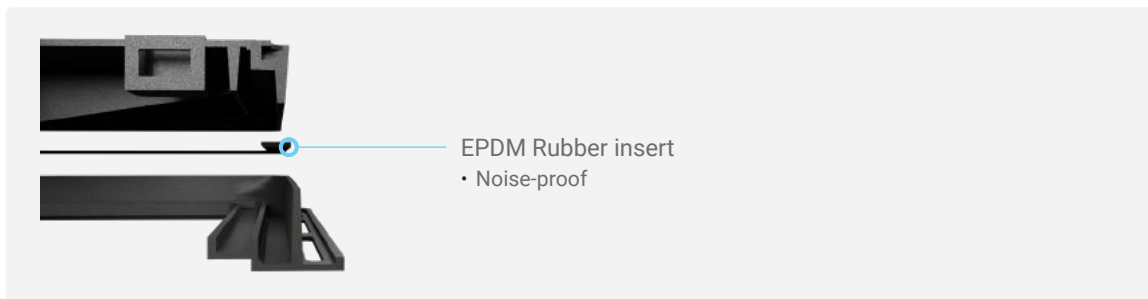

• Custom logo or lettering

Opener



INFILL ACCESS COVERS WITH HALF-V GRATES

Model Code	EN124 Class	Clear Opening(mm)	Overall Dimension (mm)	Height (mm)
KN-VG6060IF	C250	600×600	760×760	100
KN-VG8080IF	C250/D400	800×800	960×970	100

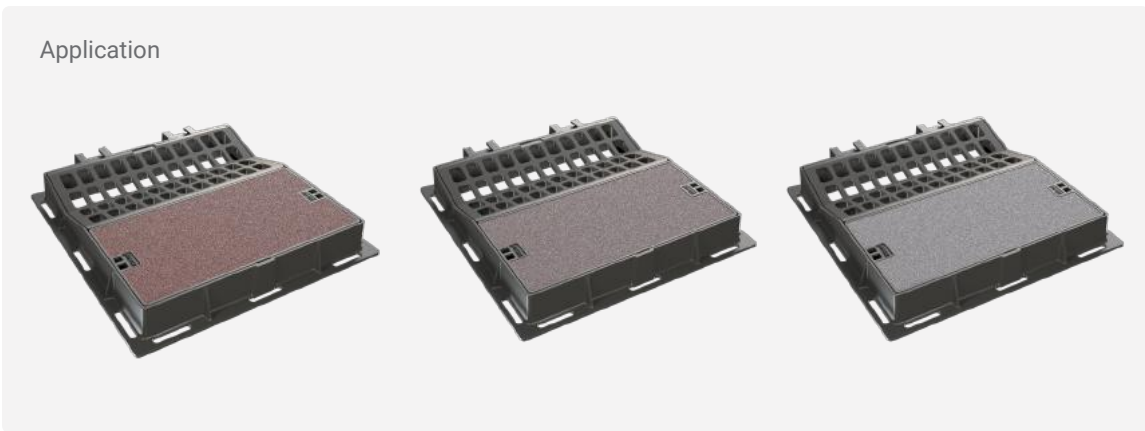

• Custom lettering

Opener



DESIGN INFILL ACCESS COVERS

SIZE	400×400 500×500 600×600 700×700 800×800 840×600 1120×620
MATERIAL	GCD500-7
STATIC LOAD	200kN ~

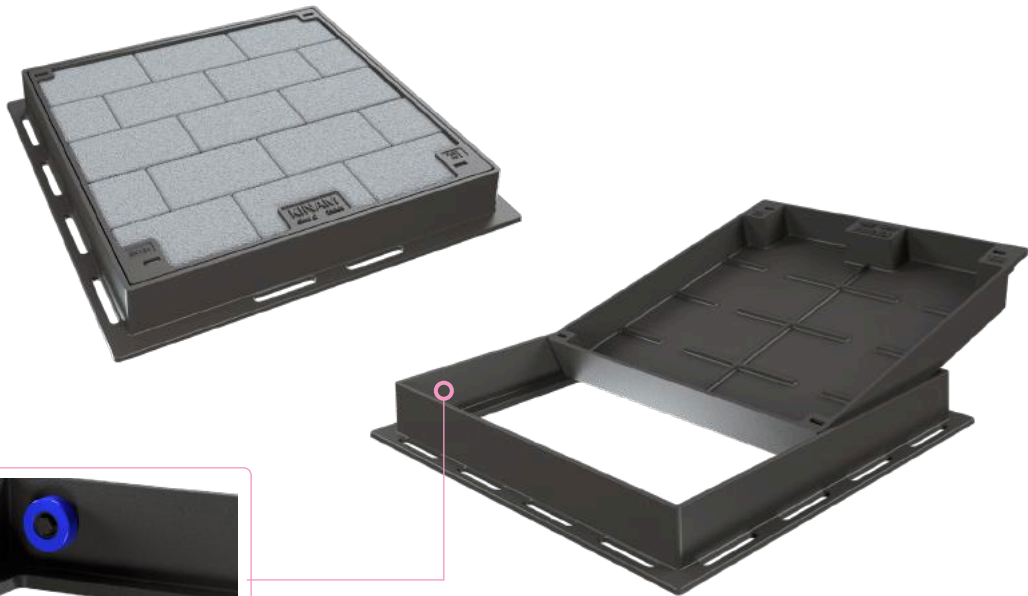

Installed a roller in the cover
 • easy and convenient open and close the cover



• Prevents noise and separation by precision
 • Vertical MCT machining



Application

- Harmonizes with urban landscape using the same material inside the cover and outside the cover

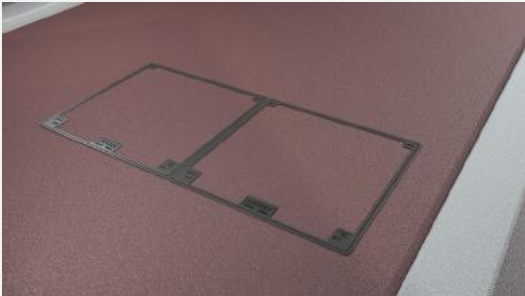
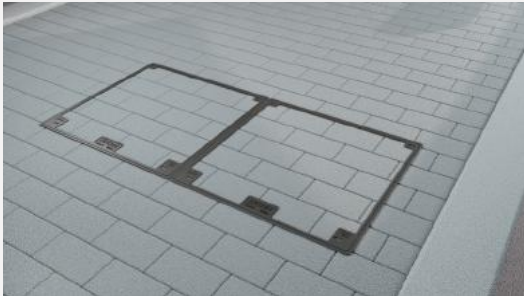
NOISELESS DRAIN COVERS

SIZE	400×1000×50 500×1000×50 600×1000×50
MATERIAL	GCD500-7
STATIC LOAD	200kN ~ 450kN



Noiseless

- Safe and durable even for large vehicles to pass
- No noise and damage when installed across slopes, regardless of slope

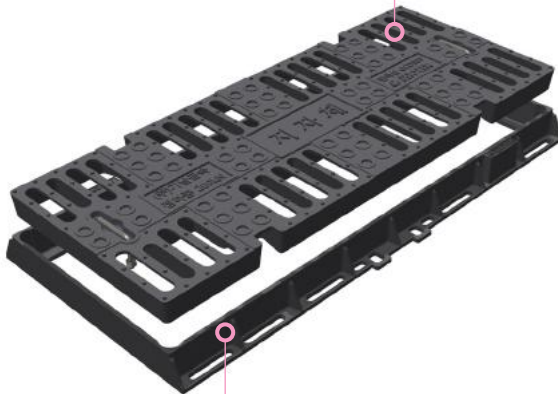

Taper vertical MCT machining

- Installed in drains in frequently damaged and noisy areas

DESIGN INFILL ACCESS COVERS







LEADING THE WORLD BEYOND KOREA

Kinam Metal is a leading company in Korean Government Procurement in the field of manhole covers since 1999.

We always try to meet customer's needs as much as possible to ensure the customer's long-term benefits. Also, we contribute to the solution of manhole covers and we do OEM as per customer's request. Buying from us, the OEM, gives you access to a wide variety of technical and engineering support. Our knowledgeable and experienced staff will be pleased to help you with all your needs.



Kinam has a wide range of products. We've been doing our best to research and develop new manhole cover with various functions such as noiseless, anti-theft, locking device, watertight, and odor-prevention. It will bring you a wide choice.

All processes are managed by the system R&D (Research and Development) and capital investment for the production of perfect products

We are also doing our best to research and develop new products.



What does an overseas sales team of Kinam do?

Kinam's overseas sales team are PROACTIVE. We don't hesitate to visit our customers or potential customers to solve a problem or suggest new ideas.

Therefore, please do not hesitate to contact us if you have any questions or concerns. You are always welcome.

E. sales@kinam.co.kr
 T. +82 53 815 6114
 W. www.kinam.co.kr/en/
 Youtube. Kinammetal



KINAM'S HISTORY

1999

10. Established Kinam Metal

2003

03. Certified ISO9001:2000 Quality Management System
05. The First Export to the United States

2006

03. Acquired as a Q Mark [Quality Assurance Company]

2008

01. Converted to Corporation as Kinam Metal Co., Ltd.
11. Awarded Industrial Design Exhibition Grand-Prix by Ministry of Trade, Industry and Energy

2009

06. Acquired GD Mark [Good Design]

2010

01. Moved the factory [Site:9,544M/C | Annual production capacity: 9,000 tons]

2011

02. Certified Main-Biz by Ministry of SMEs and Startups [No.110301-00039]
03. Established R&D Center
05. Registered as a Venture Company
12. Certified Product Performance by the Ministry of SMEs and Startups [Locking Manhole Covers & Infill Access Coverd]

2012

04. Expanded Auto Molding Line (M/C)
06. Certified Korean Government Procurement Excellent Product [Serrated Lock Manhole Covers applied with Elastic Lock]
08. Certified Korean Government Procurement Excellent Product [Infill Access Manhole Covers with roller]

2013

01. Acquired CE Mark Certification [Circular and Rectangular Noiseless Lock Manhole Covers]

2014

02. Certified Korean Government Procurement Excellent Product [Colored Infill Access Manhole Covers]
09. Acquired BS:EN124 Certification [Square/Rectangular Manhole Cover]
09. Signed MOU Agreement with "M" Company in Thailand
09. The First Export to Thailand
10. Designated by the Public Procurement Service as an Excellent Company for Overseas Public Procurement Market [PQ Mark]
11. Awarded Commendation for New Growth Company Participated in 2014 Big 5 Exhibition at World Trade Center in Dubai
12. Awarded Korean Trade Day Commendation
12. Acquired 2014 Seoul Good Public Design(SGPD)

2015

11. Designated as a Pride Product of Gyeongsanbuk-do Province
12. Designated as a Promising Export S&M Company

2016

01. Acquired BS:EN124 Certification [Circular Manhole Covers]
02. Certified G-Pass Corporate
03. Certified INNO-BIZ Certification of Technology Innovation Type SME
04. Certificate of Designation as a Leader in Water Industry

2017

12. Obtained Performance Certification of Ministry of SMEs and Startups [Rising Lock Manhole Covers]

2018

06. Signed MOU Agreement with "T" Company in Vietnam
06. The First Export to Vietnam
11. Named New Growth Company by Province of Gyeongsangbuk-do

2019

01. Acquired 2019 Seoul Good Public Design 2019 (SGPD)
02. Designated as Root-Tech Specialized Company
10. Introduced an Automated Facility Assembly Robot
12. Awarded One-Million-Dollar Export Monument Award on the 56th Korean Trade Day
12. Commendation from the Governor of Gyeongsangbuk-do on the 56th Korean Trade Day

2020

01. ISO 4500:2018 Occupational Health and Safety Assessment Series

FACILITIES & PRODUCTION PROCESS

Mass production / Error-free accuracy / Quality Management



Auto moulding line 1



Auto moulding line 2



Vertical CNC turning center (LV1100RM)
Vertical MCT machining center (1260M)



Auto-assembling Precision machine processing



ABB Auto loading assembly robot

QUALITY MANAGEMENT SYSTEM

Possible to mass production / unflinching precision / thorough quality control

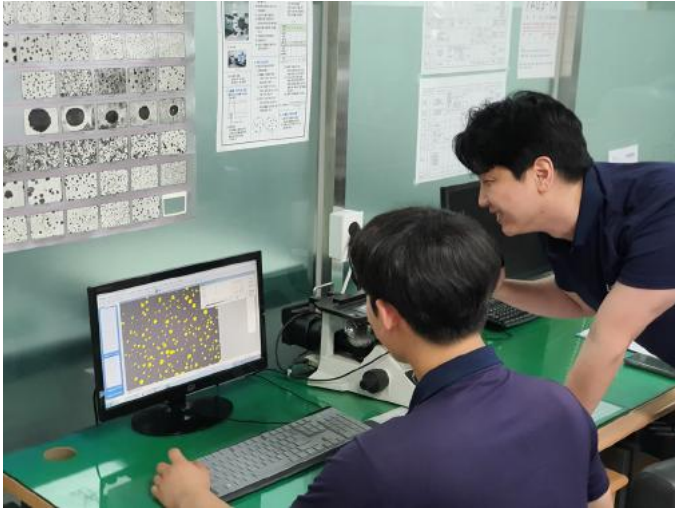

Microscopic test



Spectrometer



Metal ingredient analyzer

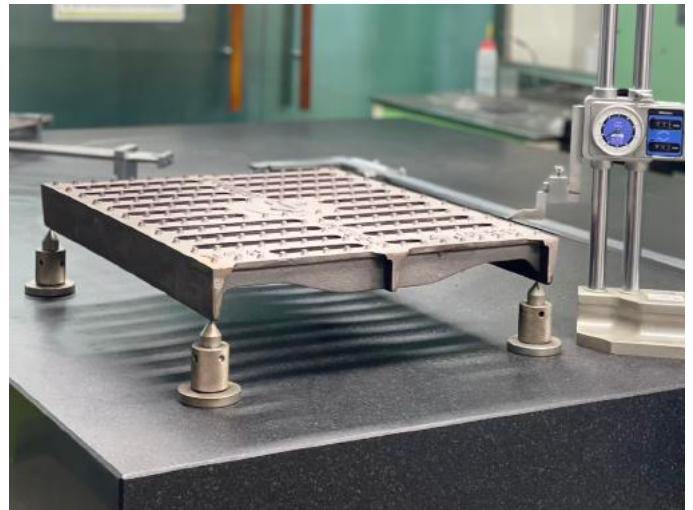

Inspection



Static load test

WE ARE ALWAYS PROACTIVE

Premium Manhole Cover

